



# InteliCharger 120 12

Inovative advanced battery charger

## Reference Guide

1 Document information .....	3
2 Charger overview .....	4
3 Wiring .....	5
4 Charger setup and operation .....	6
5 Standards and certifications .....	12
6 Mechanical specifications .....	13
7 Technical data .....	14



# Table of contents

<b>1 Document information</b>	<b>3</b>
1.1 Clarification of notation .....	3
1.2 About this guide .....	3
1.3 Legal notice .....	3
<b>2 Charger overview</b>	<b>4</b>
2.1 General description .....	4
2.2 Main characteristics .....	4
<b>3 Wiring</b>	<b>5</b>
3.1 AC input wiring diagram .....	5
3.2 Battery output wiring diagram .....	5
3.3 Wires parameters .....	5
<b>4 Charger setup and operation</b>	<b>6</b>
4.1 Front panel description .....	6
4.2 Detailed description .....	6
AC input terminal .....	6
Charging current level .....	6
Battery output terminal .....	7
Signal output terminals .....	7
Status indicators .....	7
Battery type selection .....	8
Boost charge selection .....	9
Life Test function .....	9
Power supply mode .....	9
Battery care .....	9
Charging curve .....	9
Diagnostic checks .....	10
Protection .....	10
Thermal behavior .....	10
Rail mounting .....	11
<b>5 Standards and certifications</b>	<b>12</b>
<b>6 Mechanical specifications</b>	<b>13</b>
<b>7 Technical data</b>	<b>14</b>

# 1 Document information

## 1.1 Clarification of notation

*Note: This type of paragraph calls readers attention to a notice or related theme.*

**IMPORTANT:** This type of paragraph highlights a procedure, adjustment etc., which can cause a damage or improper function of the equipment if not performed correctly and may not be clear at first sight.

**Example:** This type of paragraph contains information that is used to illustrate how a specific function works.

## 1.2 About this guide

This guide describes IntelliCharger 120 12. This guide provides general information on how to install, configure, operate and maintain the charger.

## 1.3 Legal notice

**This End User's Guide /Manual** as part of the Documentation is an inseparable part of ComAp's Product and may be used exclusively according to the conditions defined in the "USER or Distributor LICENSE AGREEMENT CONDITIONS– COMAP CONTROL SYSTEMS SOFTWARE" (License Agreement) and in the "ComAp a.s. Standard Terms for sale of Products and provision of Services" (Standard Terms)

ComAp's License Agreement is governed by the Czech Authorship Act 121/2000 Col., by international treaties and by other relevant legal documents regulating protection of the intellectual properties (TRIPS).

The End User and/or ComAp's Distributor shall only be permitted to use this End User's Guide /Manual with ComAp Control System Registered Products. The Documentation is not intended and applicable for any other purpose.

ComAp reserves the right to update this End User's Guide /Manual at any time. ComAp does not assume any responsibility for its use outside of the scope of the Standard Terms and the License Agreement.

Licensed End User is entitled to make only necessary number of copies of the End User's Guide /Manual. Any translation of this End User's Guide /Manual without the prior written consent of ComAp is expressly prohibited!

Even if the prior written consent from ComAp is acquired, ComAp does not take any responsibility for the content and quality of any such translation. ComAp will deem a translation equal to this End User's Guide/Manual only if it agrees to verify such a translation. The terms and conditions of such verification must be included in the written consent.

(missing or bad snippet)

**For more details relating to the Ownership, Extent of Permitted Reproductions Term of Use of the Documentation and to the Confidentiality rules please review and comply with the ComAp's END USER or Distributor LICENSE AGREEMENT CONDITIONS– COMAP CONTROL SYSTEMS SOFTWARE and STANDARD TERMS FOR SALE OF PRODUCTS AND PROVISION OF SERVICES available on the [www.comap.cz](http://www.comap.cz).**

## 2 Charger overview

### 2.1 General description

The IntelliCharger 120 12 is an advanced, automatic, multi-stage battery charger using “Switched mode technology” and “Battery care philosophy”, suited to meet the most advanced requirements of battery manufacturers. The battery care concept is based on algorithms that implement automatic battery charging, battery life optimization, flat batteries recovery and real time diagnosis. The real time auto-diagnostic system monitors battery faults such as cells in short circuit, accidental reverse polarity connection, disconnection of the battery. These faults can be easily detected and fixed by help of blink code of diagnostic LED during the charger installation and operation. Charger is suited for all battery types. By jumper setting it is possible to change parameters of charging curve for: Open Lead Acid, Sealed Lead Acid, Gel and NiCd–NiMH battery type. A rugged casing with bracket for DIN rail mounting provide IP20 protection degree.

### 2.2 Main characteristics

- Wide input voltage range.
- Battery charging output 12 V: 2–10 A.
- Suited for the following battery types: Open Lead Acid, Sealed Lead Acid, Lead Gel and NiCd–NiMH.
- Automatic battery status diagnosis.
- Four charging stages: Recovery, Bulk, Absorption and Float.
- Switched mode power supply technology.
- High efficiency ( $\geq 89\%$ ).
- Protected against short circuit, reversed polarity, overload and over temperature.
- Signal output terminal (voltage free contact) for discharged or damaged battery and charging fail signaling.
- Signal output terminal (voltage free contact) for Mains power input fail signaling.
- IP20 protection.
- DIN rail mounting.

# 3 Wiring

## 3.1 AC input wiring diagram

With respect to mains earthing system used, please choose proper AC input wiring.

- for TN-S (L, N, PE)
- for TN-C (L, PEN)

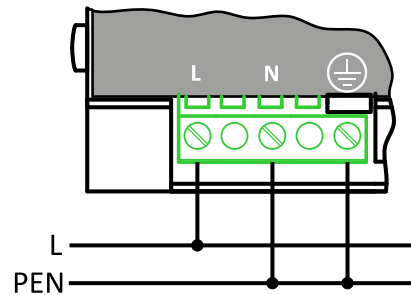
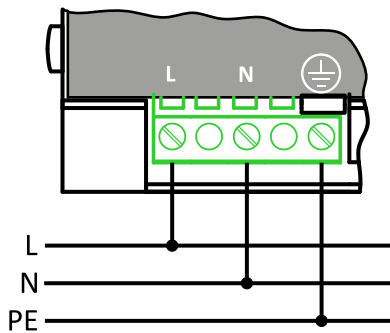

## 3.2 Battery output wiring diagram

InteliCharger 120 12 support single 12 V output. It is possible to connect one 12 V battery.

- single 12 V battery connection

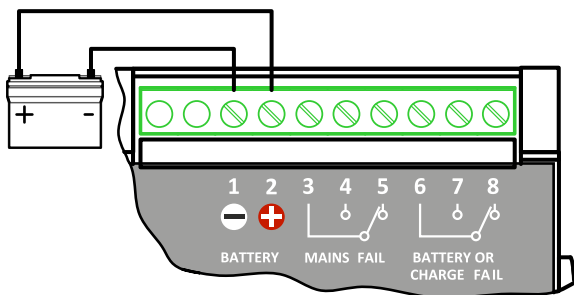

**Note:** See **Detailed description (page 1)** for charger configuration details.

## 3.3 Wires parameters

Use wires with following parameters for all connection type (Input / Output / Signal):

Solid [mm <sup>2</sup> ]	Stranded [mm <sup>2</sup> ]	AWG [-]	Torque [Nm]	Stripping length [mm]
0.2–2.5	0.2–2.5	24–14	0.5–0.6	7

**Note:** The connection is made by the screw type 2.5 mm<sup>2</sup> terminal blocks. Use only copper cables that are designed for operating temperatures higher than 75 °C.

# 4 Charger setup and operation

## 4.1 Front panel description

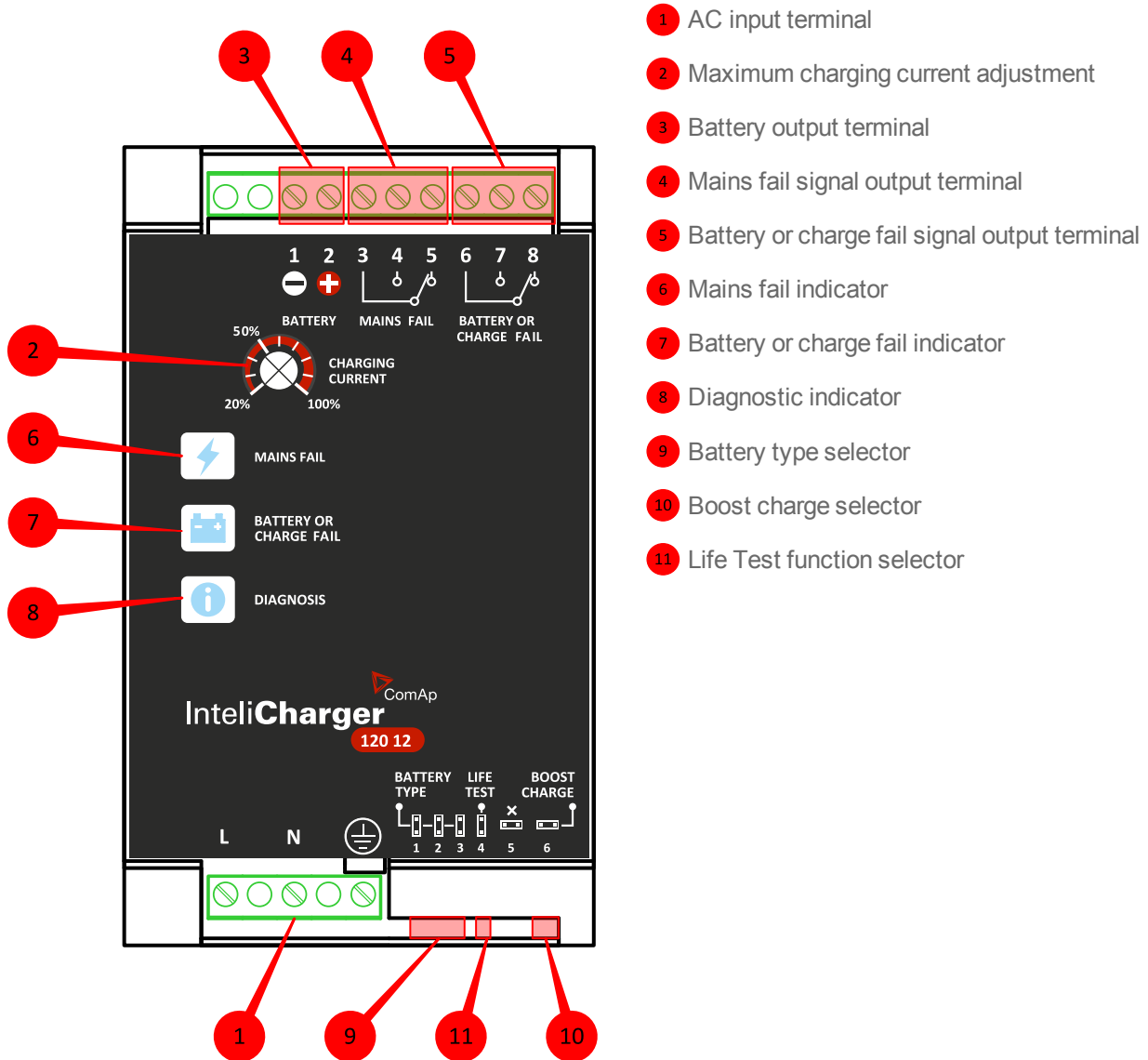

## 4.2 Detailed description

### 1 AC input terminal

Use 3 wires connection (L - phase, N - neutral, PE - protective earth) according to description in chapter **AC input wiring diagram (page 5)**.

### 2 Charging current level

Using this adjusting element it is possible to set max. charging current for battery. The current adjustment goes from 20–100 % of charger nominal current  $I_n$ . Set the maximum charging current (in A) as 20–100 % of the battery capacity (in Ah).

### 3 Battery output terminal



Connect the battery between pin 1 (- polarity) and pin 2 (+ polarity).

- use one battery (12 V) for 12 V output

See chapter **Battery output wiring diagram (page 5)** for details.

### 4 5 Signal output terminals

Isolated, voltage free, output contacts of mains fail alarm relay (pin 3,4 and 5) are active under AC input fail conditions. See details in table below.

Mains fail?	Relay output pair		Fail indicator
	pin 3–4	pin 3–5	
YES	open	closed	 – led on
NO	closed	open	 – led off

**Note:** For better system reliability set up at least 5 s input delay when signal is further processed, for example by PLC.

Isolated, voltage free, output contacts of battery or charge fail alarm relay (pin 6,7 and 8) are active under low battery, wrong battery connection, charging fail or battery to be replaced conditions. See details in table below.

Battery or charge fail?	Relay output pair		Fail indicator
	pin 6–7	pin 6–8	
YES	open	closed	 – led on
NO	closed	open	 – led off

**Note:** In Recovery the Battery or charge fail indicator  is OFF but the Relay is in failure mode (pin 6–8 closed) to indicate a battery with very low voltage.

#### Relay contact rating

Max	30 V <sub>DC</sub> , 1 A 60 V <sub>AC</sub> , 1 A	Resistive load (EN 60947-4-1)
Min	5 V <sub>DC</sub> , 1 mA	Min. permissive load.





### 6 7 8 Status indicators

 Mains fail indicator.







 Battery or charge fail indicator.

 Diagnostic indicator.

Charging phase	Diagnostic indicator	Fail indicator
----------------	----------------------	----------------

Float	1 blink / 2 s	 – led off
Absorption	1 blink / s	 – led off
Bulk	2 blink / s	 – led off
Recovery	5 blink / s	 – led off



### Charger diagnosis

State	Diagnostic indicator	Fault indicator
Reverse polarity or high battery voltage	1 blink / pause	 – led on
Battery not connected (Power supply mode)	2 blink / pause	 – led on
Cell in short circuit	3 blink / pause	 – led on
Bad battery: Internal impedance or battery connection problem (Life Test result)	5 blink / pause	 – led on
Life test not possible	6 blink / pause	 – led on
Internal fault	9 blink / pause	 – led on

## 9 Battery type selection

InteliCharger 120 12 is completely automatic charger suitable to charge most battery types. Charger can charge open lead acid, sealed lead acid, gel and NiCd–NiMH batteries.

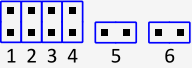
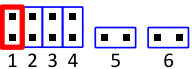
**IMPORTANT: Power off the charger before setting the jumper.**

Battery type	Jumper position	Standard Bulk, Absorption, Float cell / battery voltage	Bulk, Absorption cell / battery voltage in Boost mode
Open lead		2.23 V / 13.38 V	2.40 V / 14.40 V
Sealed lead		2.25 V / 13.50 V	2.40 V / 14.40 V
Gel		2.30 V / 13.80 V	2.40 V / 14.40 V
NiCd–NiMH		N/A	N/A

**Note:** For NiCd–NiMH batteries end-of-charge is determined by negative  $\Delta V$  detection of battery voltage ( $-5$  mV/cell). If no negative  $\Delta V$  but only a “flat” profile is detected fast charge is terminated after 10 min. General end-of-charge timeout set to 16 h. Float charge current is regulated at 10% of max current corresponding to trimmer position. In order to detect end-of-charge negative  $\Delta V$ , charging current must be set at least at 30% of nominal battery capacity (0.3 C). With lower values of charging current negative  $\Delta V$  detection is not guaranteed.



## 10 Boost charge selection

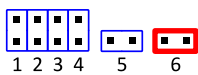



Set jumper on position 6 to enable boost charging. Using this option charging voltage in Bulk and Absorption stage is adjusted to 14.40 V (2.40 V / cell).

This option is not applicable for NiCd–NiMH batteries.

**Note:** It is allowed to set this option when charger is powered.

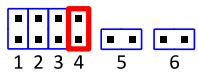
## 11 Life Test function



Charger check periodically battery internal impedance and determines whether the battery is sulphated when Life Test function is enabled. Test is performed every two hours during float charging stage. Two consecutively checks with the same result have to be performed prior Life Test results are announced. If a sulphated battery is detected, this fault is signaled by battery or charge fail indicator , battery or charge fail relay is in failure mode (pin 6–8 closed) and diagnostic indicator  is blinking 5 blink code. During fault signaling the charger operates as usual and continues with charging the battery.

**Note:** It is essential to connect battery properly to ensure right results of battery life test function.

## Power supply mode

The charger is switched automatically to power supply mode when there is no battery connected to charger battery output. Output voltage is the float charging voltage and depends on battery type selected. See **Battery type selection (page 8)** for details. Maximum output current in power supply mode is the same as maximum charging current.

## Battery care

The Battery Care philosophy is based on algorithms that implement rapid and automatic charging, battery charge optimization, flat batteries recovery and real time diagnosis. The realtime auto-diagnostic system monitors battery and charging proces during the installation and operation. Faults such as cells in short circuit, accidental reverse polarity connection, disconnection of the battery, can be easily detected and fixed by help of blink code of diagnosis indicator. The charger is suited for all battery types. It is possible to choose predefined charging curves for Open Lead Acid, Sealed Lead Acid, Gel and NiCd–NiMH battery. Battery reliability in time is guaranteed by continuously testing the internal impedance status. It avoids any possible risk of damages and grants also a permanent, reliable and safe connection of the battery to the charger. The system, through a battery stimulation circuit with algorithms of evaluation of the detected parameter, is able to recognize batteries with a short-circuited cell.

## Charging curve

Automatic multi-stage operation and real time diagnosis allows fast recharge and recovery of deeply discharged batteries, adding value and reliability to the system hosting the IntelliCharger 120 12 device. The type of charging is Voltage stabilized and Current stabilized IUoU.

Each of four charging stage is identified by a flashing code on the Diagnosis indicator.

To maintain the output battery voltage in lower levels, don't enable boost charging. (No jumper set in position 6.)

There are four charging stages:

- recovery
- bulk

- absorption
- float.

You can see details in charging curve diagram below:

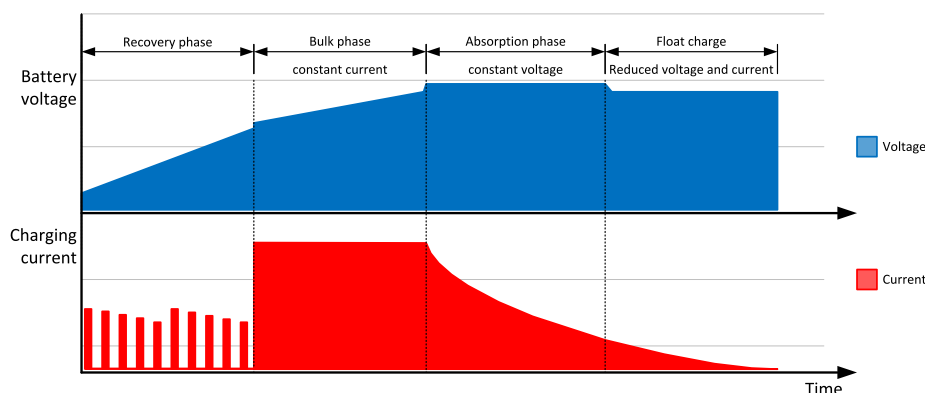

## Diagnostic checks

- **accidental battery cable disconnection**
  - when detected, output power is switched off
- **battery not connected**
  - when detected, output power is switched off
- **reverse polarity**
  - when detected, charger is automatically protected
- **battery voltage**
  - to prevent connection of wrong battery types, with higher or lower voltage than the nominal voltage
- **end of charge**
  - when battery is full, charger goes into float charging
- **battery cells in short circuit**
  - performed every 4 hours in float charge

## Protection

- **primary side**
  - The charger is equipped with an internal fuse. If the internal fuse is blown, it is most probable that there is a fault in the device. If happen, the device must be checked by manufacturer.
- **secondary side**
  - The charger is electrically protected against short circuits and overload. Output current is electronically limited.
  - The charger is automatically protected against reversed battery polarity.

## Thermal behavior

Standard surrounding air temperature is up to 50 °C. For ambient temperature over this limit, the output current is reduced by 2.5 % per °C. Maximum temperature is 70 °C. At the temperature 70°C the output current will be 50% of nominal current. The charger does not switch off in case of ambient temperature above 70°C or in case

of thermal overload. The device is protected for over temperature conditions “worst case”. In this situation the device shut-down the output and automatically restart when internal temperature fall down into limits.

## Rail mounting

The charger module must have a minimum vertical and horizontal distance of 10 cm to the other used DIN rail modules in order to guarantee sufficient auto convection for proper cooling.

**IMPORTANT: Depending on the ambient temperature and load of the charger, the temperature of the housing can become very high!**

DIN rail mounting

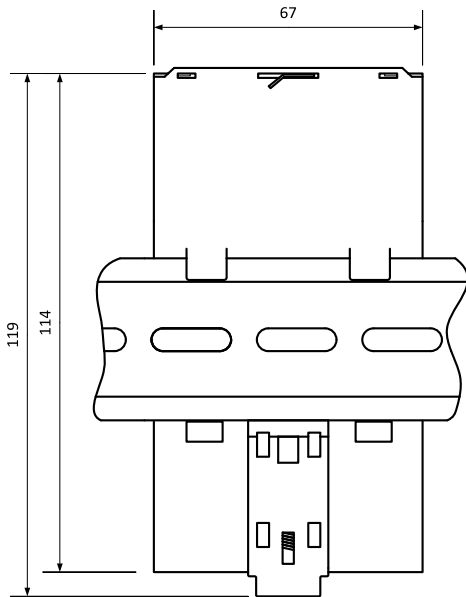

## 5 Standards and certifications

### **Electrical Safety:**

Assembling device: IEC/EN 60950 (VDE 0805) and EN 50178 (VDE 0160).

Installation according: IEC/EN 60950.

Input / Output separation: SELV EN 60950-1 and PELV EN 60204-1. Double or reinforced insulation.

### **EMC Standards Immunity:**

EN 61000-4-2, EN 61000-4-3, EN 61000-4-4, EN 61000-4-5.

### **EMC Standards Emission:**

EN 61000-6-4, EN 61000-6-3, EN 61000-3-2

### **Standards Conformity:**

Safety of Electrical Equipment Machines: EN 60204-1.

The CE mark in According to EMC 2004/108/EC and Low voltage directive 2006/95/EEC.

### **In conformity to:**

UL1236, IEC/EN 60335-2-29 Battery chargers; EN60950 / UL1950; Electrical safety EN54-4 Fire Detection and fire alarm systems; 89/336/EEC EMC Directive; 2006/95/EC (Low Voltage); DIN41773 (Charging cycle); Emission: IEC 61000-6-4; Immunity: IEC 61000-6-2. CE.

# 6 Mechanical specifications

Case	A rugged aluminum case for DIN rail mounting with top and bottom perforation for auto convection cooling.
Weight	0.65 kg (1.43 lbs)
Dimension (W×H×D)	72 mm × 114 mm × 136 mm (2.83" × 4.48" × 5.35")

## Drawing and dimensions

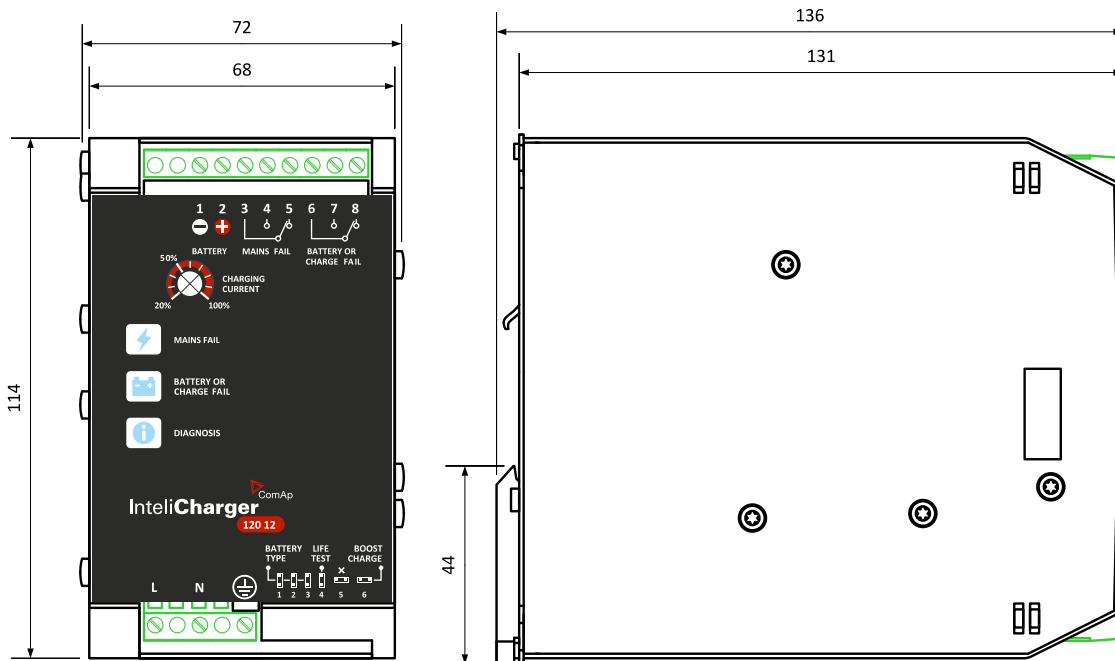

# 7 Technical data

## Input data

Nominal input voltage	115 / 230 V <sub>AC</sub>
Input voltage range	90–305 V <sub>AC</sub>
Inrush current (V <sub>n</sub> and I <sub>n</sub> load)	≤ 16 A, ≤ 5 ms
Frequency	47–63 Hz ± 6 %
Input current (115–230 V <sub>AC</sub> )	2.4–1.2 A
Internal fuse	4 A
Recommended external fuse	10 A (MCB curve B)

## Output data

Output V <sub>DC</sub> / I <sub>n</sub>	12 V <sub>DC</sub> / 10 A
Efficiency (50 % of I <sub>n</sub> )	≥ 89 %
Ripple voltage	≤ 80 mV <sub>pp</sub>

## Protection

Short-circuit protection	Yes
Overload protection	Yes
Overvoltage output protection	Yes
Reverse battery polarity protection	Yes
Detection of cell in short-circuit	Yes
Thermal protection	Yes

## General data

Operating temperature range	-25–+70 °C
Storage temperature range	-40–+85 °C
Max humidity (25 °C)	95 %
IP protection class (EN/IEC 60529)	IP20
Reliability (MTBF IEC 61709)	> 300 000 h
Protection class (with PE connected)	I
Dimension (w×h×d)	72 mm × 114 mm × 136 mm
Weight	approx. 0.65 kg