

InteliCharger 120 12-24

Inovative advanced dual voltage battery charger

Reference Guide

1 Document information	3
2 Charger overview	4
3 Wiring	5
4 Charger setup and operation	6
5 Standards and certifications	11
6 Mechanical specifications	12
7 Technical data	13



Table of contents

1 Document information	3
1.1 Clarification of notation	3
1.2 About this guide	3
1.3 Legal notice	3
2 Charger overview	4
2.1 General description	4
2.2 Main characteristics	4
3 Wiring	5
3.1 AC input wiring diagram	5
3.2 Battery output wiring diagram	5
3.3 Wires parameters	5
4 Charger setup and operation	6
4.1 Front panel description	6
4.2 Detailed description	6
AC input terminal	6
Charging current level	6
Battery output terminal	6
Signal output terminal	7
Status indicators	7
Battery type selection	8
Boost charge selection	8
Output battery voltage selection	8
Power supply mode	8
Battery care	9
Charging curve	9
Diagnostic checks	9
Protection	10
Thermal behavior	10
Rail mounting	10
5 Standards and certifications	11
6 Mechanical specifications	12
7 Technical data	13

1 Document information

1.1 Clarification of notation

Note: This type of paragraph calls readers attention to a notice or related theme.

IMPORTANT: This type of paragraph highlights a procedure, adjustment etc., which can cause a damage or improper function of the equipment if not performed correctly and may not be clear at first sight.

Example: This type of paragraph contains information that is used to illustrate how a specific function works.

1.2 About this guide

This guide describes IntelliCharger 120 12-24. This guide provides general information on how to install, configure, operate and maintain the charger.

1.3 Legal notice

This End User's Guide /Manual as part of the Documentation is an inseparable part of ComAp's Product and may be used exclusively according to the conditions defined in the "USER or Distributor LICENSE AGREEMENT CONDITIONS– COMAP CONTROL SYSTEMS SOFTWARE" (License Agreement) and in the "ComAp a.s. Standard Terms for sale of Products and provision of Services" (Standard Terms)

ComAp's License Agreement is governed by the Czech Authorship Act 121/2000 Col., by international treaties and by other relevant legal documents regulating protection of the intellectual properties (TRIPS).

The End User and/or ComAp's Distributor shall only be permitted to use this End User's Guide /Manual with ComAp Control System Registered Products. The Documentation is not intended and applicable for any other purpose.

ComAp reserves the right to update this End User's Guide /Manual at any time. ComAp does not assume any responsibility for its use outside of the scope of the Standard Terms and the License Agreement.

Licensed End User is entitled to make only necessary number of copies of the End User's Guide /Manual. Any translation of this End User's Guide /Manual without the prior written consent of ComAp is expressly prohibited!

Even if the prior written consent from ComAp is acquired, ComAp does not take any responsibility for the content and quality of any such translation. ComAp will deem a translation equal to this End User's Guide/Manual only if it agrees to verify such a translation. The terms and conditions of such verification must be included in the written consent.

(missing or bad snippet)

For more details relating to the Ownership, Extent of Permitted Reproductions Term of Use of the Documentation and to the Confidentiality rules please review and comply with the ComAp's END USER or Distributor LICENSE AGREEMENT CONDITIONS– COMAP CONTROL SYSTEMS SOFTWARE and STANDARD TERMS FOR SALE OF PRODUCTS AND PROVISION OF SERVICES available on the www.comap.cz.

2 Charger overview

2.1 General description

The IntelliCharger 120 12-24 is an advanced, automatic, multi-stage battery charger using “Switched mode technology” and “Battery care philosophy”, suited to meet the most advanced requirements of battery manufacturers. The battery care concept is based on algorithms that implement automatic battery charging, battery life optimization, flat batteries recovery and real time diagnosis. The real time auto-diagnostic system monitors battery faults such as cells in short circuit, accidental reverse polarity connection, disconnection of the battery. These faults can be easily detected and fixed by help of blink code of diagnostic LED during the charger installation and operation. Charger is suited for all battery types. By jumper setting it is possible to change parameters of charging curve for: Open Lead Acid, Sealed Lead Acid, Gel and NiCd–NiMH battery type. A rugged casing with bracket for DIN rail mounting provide IP20 protection degree.

2.2 Main characteristics

- Wide input voltage range.
- Battery charging output 24 V: 1–5 A, 12 V: 1.2–6 A.
- Suited for the following battery types: Open Lead Acid, Sealed Lead Acid, Lead Gel and NiCd–NiMH.
- Automatic battery status diagnosis.
- Four charging stages: Recovery, Bulk, Absorption and Float.
- Switched mode power supply technology.
- High efficiency ($\geq 90\%$).
- Protected against short circuit, reversed polarity, overload and over temperature.
- Signal output terminal (voltage free contact) for discharged or damaged battery and charging fail signaling.
- IP20 protection.
- DIN rail mounting.

3 Wiring

3.1 AC input wiring diagram

With respect to mains earthing system used, please choose proper AC input wiring.

- for TN-S (L, N, PE)
- for TN-C (L, PEN)

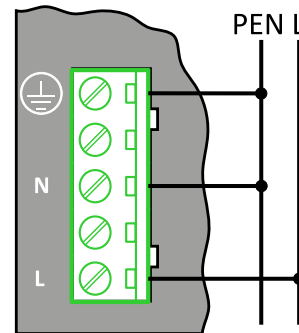
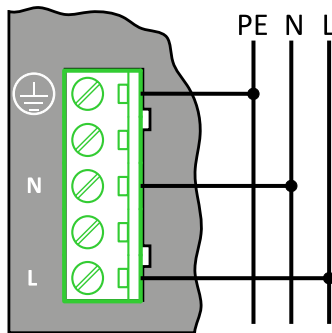

3.2 Battery output wiring diagram

InteliCharger 120 12-24 support dual voltage output. It is possible to connect one or two 12 V battery to its output.

- for single 12 V battery
- for two (in series) 12 V batteries

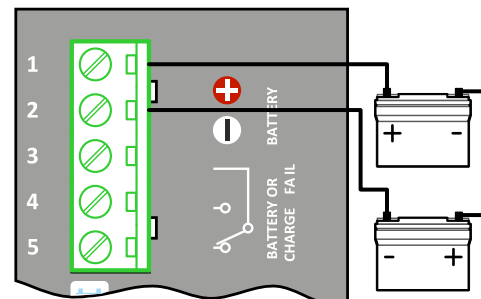
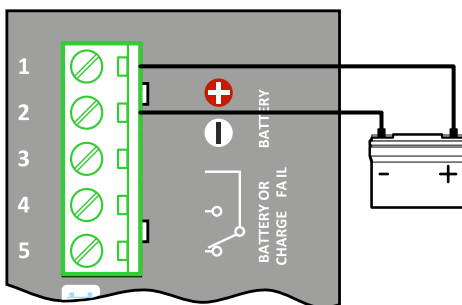

no jumper in position 6

jumper set in position 6

Note: See **Detailed description (page 6)** for charger configuration details.

3.3 Wires parameters

Use wires with following parameters for all connection type (Input / Output / Signal):

Solid [mm ²]	Stranded [mm ²]	AWG [-]	Torque [Nm]	Stripping length [mm]
0.2–2.5	0.2–2.5	24–14	0.5–0.6	7

Note: The connection is made by the screw type 2.5 mm² terminal blocks. Use only copper cables that are designed for operating temperatures higher than 75 °C.

4 Charger setup and operation

4.1 Front panel description

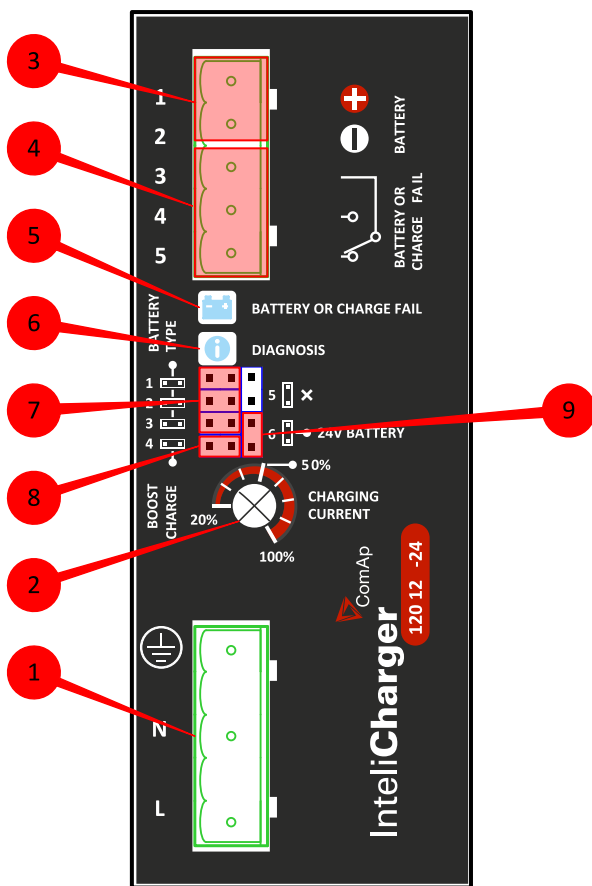

- 1 AC input terminal
- 2 Maximum charging current adjustment
- 3 Battery output terminal
- 4 Signal output terminal
- 5 Battery or charge fail indicator
- 6 Diagnostic indicator
- 7 Battery type selector
- 8 Boost charge selector
- 9 Output battery voltage (12/24 V) selector

4.2 Detailed description

1 AC input terminal

Use 3 wires connection (L - phase, N - neutral, PE - protective earth) according to description in chapter **AC input wiring diagram (page 5)**.

2 Charging current level

Using this adjusting element it is possible to set max. charging current for battery. The current adjustment goes from 20–100 % of charger nominal current I_n . Set the maximum charging current (in A) as 20–100 % of the battery capacity (in Ah).

3 Battery output terminal



Connect the battery between pin 1 (+ polarity) and pin 2 (- polarity).

- use one battery (12 V) for 12 V output
- use two batteries (12 V) connected in serial for 24 V output

See chapter **Battery output wiring diagram (page 5)** for details.

4 Signal output terminal

Isolated, voltage free, output contacts of fault alarm relay (pin 3,4 and 5) are active under low battery, wrong battery connection, charging fail or battery to be replaced conditions. See details in table below.

Battery charge fail?	Relay output pair		Fail indicator
	pin 3–4	pin 3–5	
YES	open	closed	 – led on
NO	closed	open	 – led off

Note: In Recovery the Battery or charge fail indicator  is OFF but the Relay is in failure mode (pin 3–5 closed) to indicate a battery with very low voltage.





Relay contact rating

Max	30 V _{DC} , 1 A 60 V _{AC} , 1 A	Resistive load (EN 60947-4-1)
Min	5 V _{DC} , 1 mA	Min. permissive load.





5 6 Status indicators

 Battery or charge fail indicator.

 Diagnostic indicator.

Charging phase	Diagnostic indicator	Fail indicator
Float	1 blink / 2 s	 – led off
Absorption	1 blink / s	 – led off
Bulk	2 blink / s	 – led off
Recovery	5 blink / s	 – led off





Charger diagnosis

State	Diagnostic indicator	Fault indicator
Reverse polarity or wrong battery voltage (for example: charger is set for 24 V but battery is 12 V)	1 blink / pause	 – led on
Battery not connected (Power supply mode)	2 blink / pause	 – led on
Cell in short circuit	3 blink / pause	 – led on
Low battery voltage	9 blink / pause	 – led on
High battery voltage	10 blink / pause	 – led on

7 Battery type selection

InteliCharger 120 12-24 is completely automatic charger suitable to charge most battery types. Charger can charge open lead acid, sealed lead acid, gel and NiCd–NiMH batteries.

IMPORTANT: Power off the charger before setting the jumper.

Battery type	Jumper position	Standard Bulk, Absorption, Float cell / battery voltage	Bulk, Absorption cell / battery voltage in Boost mode
Open lead		2.23 V / 13.38 V	2.40 V / 14.40 V
Sealed lead		2.25 V / 13.50 V	2.40 V / 14.40 V
Gel		2.30 V / 13.80 V	2.40 V / 14.40 V
NiCd–NiMH		N/A	N/A

Note: For NiCd–NiMH batteries end-of-charge is determined by negative ΔV detection of battery voltage (-5 mV/cell). If no negative ΔV but only a “flat” profile is detected fast charge is terminated after 10 min. General end-of-charge timeout set to 16 h. Float charge current is regulated at 10% of max current corresponding to trimmer position. In order to detect end-of-charge negative ΔV , charging current must be set at least at 30% of nominal battery capacity (0.3 C). With lower values of charging current negative ΔV detection is not guaranteed.

8 Boost charge selection

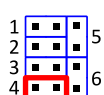

Set jumper on position 4 to enable boost charging. Using this option charging voltage in Bulk and Absorption stage is adjusted to 14.40 V (2.40 V / cell).

This option is not applicable for NiCd–NiMH batteries.

Note: It is allowed to set this option when charger is powered.

9 Output battery voltage selection

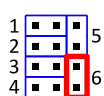

Output battery voltage is selected using position 6 jumper.

- set no jumper on position 6 for 12 V output
- set jumper on position 6 for 24 V output.

Note: It is allowed to set this option when charger is powered.

Power supply mode

The charger is switched automatically to power supply mode when there is no battery connected to charger battery output. Output voltage is the float charging voltage and depends on battery type selected. See **Battery type selection (page 8)** for details. Maximum output current in power supply mode is the same as maximum charging current.

Battery care

The Battery Care philosophy is based on algorithms that implement rapid and automatic charging, battery charge optimization, flat batteries recovery and real time diagnosis. The realtime auto-diagnostic system monitors battery and charging proces during the installation and operation. Faults such as cells in short circuit, accidental reverse polarity connection, disconnection of the battery, can be easily detected and fixed by help of blink code of diagnosis indicator. The charger is suited for all battery types. It is possible to choose predefined charging curves for Open Lead Acid, Sealed Lead Acid, Gel and NiCd–NiMH battery. Battery reliability in time is guaranteed by continuously testing the internal impedance status. It avoids any possible risk of damages and grants also a permanent, reliable and safe connection of the battery to the charger. The system, through a battery stimulation circuit with algorithms of evaluation of the detected parameter, is able to recognize batteries with a short-circuited cell.

Charging curve

Automatic multi-stage operation and real time diagnosis allows fast recharge and recovery of deeply discharged batteries, adding value and reliability to the system hosting the IntelliCharger 120 12-24 device. The type of charging is Voltage stabilized and Current stabilized IUoU.

Each of four charging stage is identified by a flashing code on the Diagnosis indicator.

To maintain the output battery voltage in lower levels, don't enable boost charging. (No jumper set in position 4.)

There are four charging stages:

- recovery
- bulk
- absorption
- float.

You can see details in charging curve diagram below:

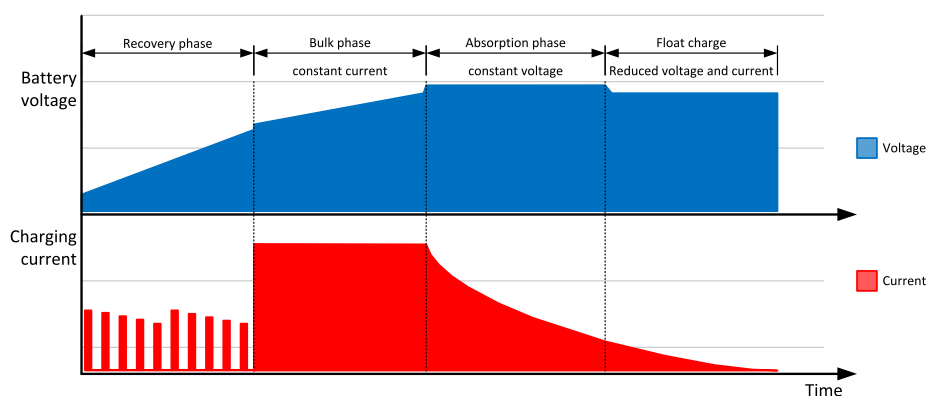

Diagnostic checks

- **accidental battery cable disconnection**
 - when detected, output power is switched off
- **battery not connected**
 - when detected, output power is switched off
- **reverse polarity**
 - when detected, charger is automatically protected

- **battery voltage**
 - to prevent connection of wrong battery types, with higher or lower voltage than the nominal voltage
- **end of charge**
 - when battery is full, charger goes into float charging
- **battery cells in short circuit**
 - performed every 4 hours in float charge

Protection

- **primary side**
 - The charger is equipped with an internal fuse. If the internal fuse is blown, it is most probable that there is a fault in the device. If happen, the device must be checked by manufacturer.
- **secondary side**
 - The charger is electrically protected against short circuits and overload. Output current is electronically limited.
 - The charger is automatically protected against reversed battery polarity.

Thermal behavior

Standard surrounding air temperature is up to 50 °C. For ambient temperature over this limit, the output current is reduced by 2.5 % per °C. Maximum temperature is 70 °C. At the temperature 70°C the output current will be 50% of nominal current. The charger does not switch off in case of ambient temperature above 70°C or in case of thermal overload. The device is protected for over temperature conditions “worst case”. In this situation the device shut-down the output and automatically restart when internal temperature fall down into limits.

Rail mounting

The charger module must have a minimum vertical and horizontal distance of 10 cm to the other used DIN rail modules in order to guarantee sufficient auto convection for proper cooling.

IMPORTANT: Depending on the ambient temperature and load of the charger, the temperature of the housing can become very high!

DIN rail mounting

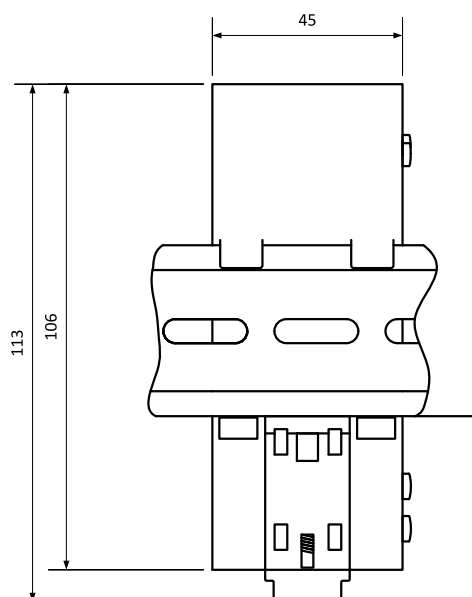

5 Standards and certifications

Electrical Safety:

Assembling device: IEC/EN 60950 (VDE 0805) and EN 50178 (VDE 0160).

Installation according: IEC/EN 60950.

Input / Output separation: SELV EN 60950-1 and PELV EN 60204-1. Double or reinforced insulation.

EMC Standards Immunity:

EN 61000-4-2, EN 61000-4-3, EN 61000-4-4, EN 61000-4-5.

EMC Standards Emission:

EN 61000-6-4, EN 61000-6-3, EN 61000-3-2

Standards Conformity:

Safety of Electrical Equipment Machines: EN 60204-1.

The CE mark in According to EMC 2004/108/EC and Low voltage directive 2006/95/EEC.

In conformity to:

UL1236, IEC/EN 60335-2-29 Battery chargers; EN60950 / UL1950; Electrical safety EN54-4 Fire Detection and fire alarm systems; 89/336/EEC EMC Directive; 2006/95/EC (Low Voltage); DIN41773 (Charging cycle); Emission: IEC 61000-6-4; Immunity: IEC 61000-6-2. CE.

6 Mechanical specifications

Case	A rugged aluminum case for DIN rail mounting with top and bottom perforation for auto convection cooling.
Weight	0.30 kg (0.66 lbs)
Dimension (W×H×D)	47 mm × 115 mm × 111 mm (1.85" × 4.53" × 4.37")

Drawing and dimensions

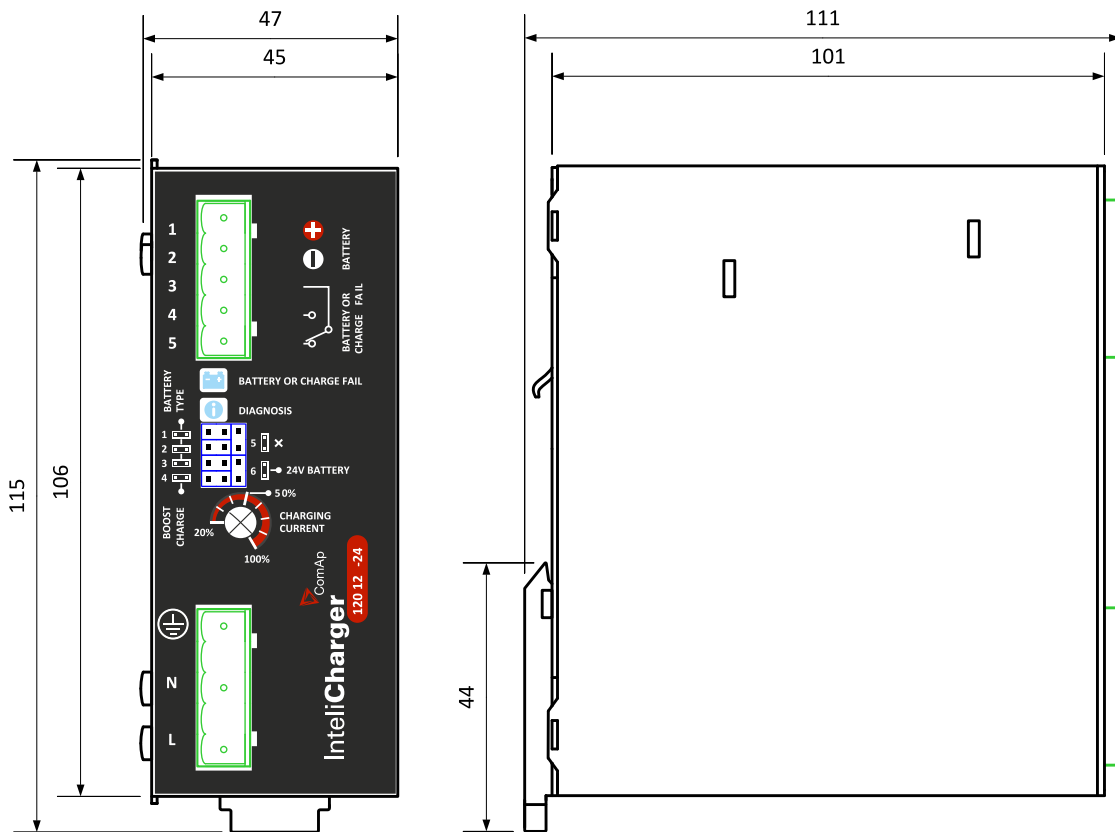

7 Technical data

Input data

Nominal input voltage	115 / 230 V _{AC}
Input voltage range	90–305 V _{AC}
Inrush current (V _n and I _n load)	≤ 16 A, ≤ 5 ms
Frequency	47–63 Hz ± 6 %
Input current (115–230 V _{AC})	2.4–1.2 A
Internal fuse	4 A
Recommended external fuse	10 A (MCB curve B)

Output data

Output V _{DC} / I _n	12 V _{DC} / 6A 24 V _{DC} / 5A
Efficiency (50 % of I _n)	≥ 90 %
Ripple voltage	≤ 80 mV _{pp}

Protection

Short-circuit protection	Yes
Overload protection	Yes
Overvoltage output protection	Yes
Reverse battery polarity protection	Yes
Detection of cell in short-circuit	Yes
Thermal protection	Yes

General data

Operating temperature range	-25–+70 °C
Storage temperature range	-40–+85 °C
Max humidity (25 °C)	95 %
IP protection class (EN/IEC 60529)	IP20
Reliability (MTBF IEC 61709)	> 300 000 h
Protection class (with PE connected)	I
Dimension (w×h×d)	47 mm × 115 mm × 111 mm
Weight	approx. 0.30 kg