

# **AVR 380 SERIES**

(AUTOMATIC VOLTAGE REGULATOR)

This unit will replace the following AVR's:  
Caterpillar, Dunlite, Stamford, Markon Contrology, Stone,  
McColl, Brush, Modra, Arrow, Kato, Artemus, Taiyo, Lister,  
Newton Derby, Reliance, Marathon, Kubota, Basler  
and many more

**Email Address: [info@powersystems.com.au](mailto:info@powersystems.com.au)**  
**Web Address: [www.powersystems.com.au](http://www.powersystems.com.au)**

## ***Power Drive Systems***

### AVR 380 AUTOMATIC VOLTAGE REGULATOR

#### **1. INTRODUCTION**

The AVR 380 is a solid state device, which is designed to give accurate and stable voltage regulation of alternators.

The AVR is suitable for regulating 50 or 60Hz brushless, rotating or stationary field alternators regardless of prime mover type and will replace most electronic regulators with or without separate excitation.

The AVR is suitable for one or three phase alternators and has four selectable voltage sensing ranges available. ie: 120, 208, 240 and 415V.

The AVR is suitable for parallel operation of alternators with quadrature droop facilities with only an additional standard 5 amp current transformer and resistor being required.

The AVR has several features:

- Voltage adjustment  $\pm$  10% over each range
- Overload sensing and shutdown, plus opto isolator for remote indication
- Wide range of stability
- Underspeed adjustment which will provide voltage droop with large motor starting loads, this feature will provide excellent starting characteristics and prevent unnecessary stalling of the prime mover
- Remote voltage adjustment available
- Optional over voltage crow bar protection circuit is available which will blow the fuse, further protecting the load (order before delivery from factory)
- Optional voltage trim from external +/- 5 volt supply (order before delivery from factory)
- Transformer isolated voltage sensing

#### **2. OPERATION**

The regulator senses the alternator output and derives excitation power from the 3 phase connections to the alternator output.

Regulation and stability is maintained provided the prime mover speed is within governor class A1 to IS03046, at any machine load or power factor by comparing the sensed voltage with an internal reference point.

The unit constantly adjusts the field excitation level to compensate for voltage difference between the sensed voltage and reference.

Output voltage of the machine will be held to  $\pm$  1.5% including cold to hot variations in ambient conditions of -10 deg. to +60 deg. and engine speed changes of  $\pm$  4% from preset nominal.

## **Power Drive Systems**

### AVR 380 AUTOMATIC VOLTAGE REGULATOR

#### **3. CONSTRUCTION**

The assembled PCB is solidly mounted in a folded aluminium housing which provides the necessary mechanical protection and is suitable to mount directly in the alternator terminal box or in the separate control cubicle.

All components used are selected for stable operation in ambients ranging from -10 deg. to 70 deg. and severely capacity derated for high reliability.

The printed circuit board is a 1.5mm reinforced fibreglass with double sided tracks and plated through holes.

#### **4. CONTROLS**

There are 5 standard and one optional control on each AVR.

##### **a. STABILITY I - R9**

This potentiometer adjusts the stability and response of the alternator and should initially be set in a counter-clockwise position and rotate clockwise to give optimum stability and response characteristics. Once set, no further adjustment should be necessary.

Full CCW position gives maximum response, minimum stability.

Full CW position gives minimum response, maximum stability.

##### **b. VOLTAGE ADJUST - R5**

This potentiometer varies the reference voltage and hence the amount of excitation of the alternator which adjusts the output voltage over a range of  $\pm 10\%$ .

An external 5K potentiometer may be added to terminals P.P. for remote panel voltage adjustment. When this is used the loop on P.P. is removed and the internal pot is turned to maximum.

##### **c. UNDERSPEED - R17**

This potentiometer sets the frequency at which voltage drooping with speed will occur.

For example, if set at 48Hz and a large motor is started which temporarily overloads the prime mover on starting, once the speed falls to 48Hz the alternator voltage will decrease and act as an automatic reduced voltage starter and greatly assist in motor starting.

##### **d. OVERLOAD - R28**

This potentiometer sets the maximum permissible field excitation should the engine speed remain constant whilst the alternator is overloaded. Allowances are made for temporary overloaded by a non-adjustable built in 15 seconds delay. Once the overload does trip, the output voltage falls to approximately 50 volts and can only be reset by stopping the engine.

##### **e. STABILITY II - Located on PCB next to IC.I - R10**

This potentiometer widens the range of stability and should always be normally fully anti-clockwise and only adjusted slightly clockwise to counter further stability should 'Stability I' run out of range particularly on **single phase machines**.

Set stability II fully anti-clockwise for 3 phase or clockwise for 1 phase.

## Power Drive Systems

### AVR 380 AUTOMATIC VOLTAGE REGULATOR

f. **OVER VOLTAGE** (Optional)

5. **ADJUSTMENTS**

a. **VOLTAGE**

The AVR sensing voltage must be first selected for the required sensing voltage. Adjacent to the transformer are four pins connected to the relevant pin to match the available sensing output of the alternator. 120, 208, 240 and 415 Volts.

**Note:**

**If replacing other electronic regulators for convenience use the same sensing connections if possible.**

b. **STABILITY**

Rotate clockwise to increase stability.

To check, if after sudden load change prolonged fluctuation occurs, turn stability slightly clockwise, or if voltage is very slow to recover from load changes then counter clockwise.

c. **UNDERSPEED**

To adjust the alternator must be running at the correct speed. ie.  $50\text{Hz} \pm$  at no load.

Connect an AC voltmeter across the output of the alternator and slowly turn the underspeed potentiometer clockwise until the voltage just starts to fall, then turn slightly counterclockwise, approx 30 deg.

To check, apply full load if possible and voltage should not droop more than 1%. Or alternatively lower speed to 48Hz and voltage should droop.

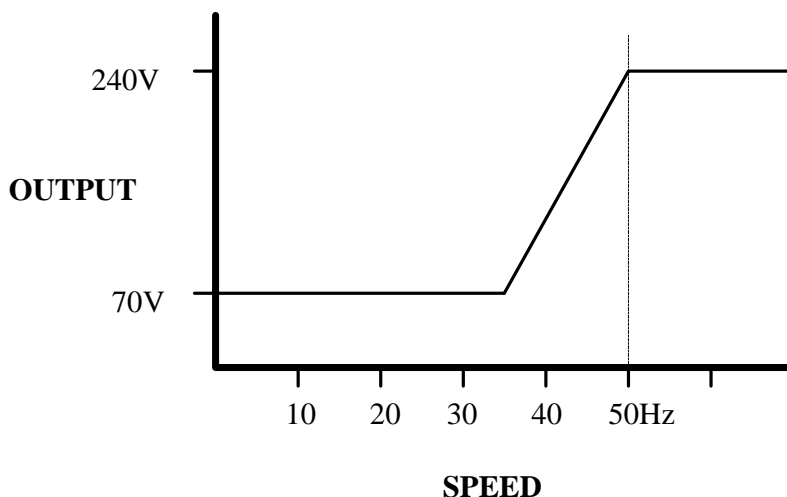

## Power Drive Systems

### AVR 380 AUTOMATIC VOLTAGE REGULATOR

#### d. OVERLOAD

**Note:**

**Some alternator manufacturers state maximum field voltage or scoop setting, these will correspond to overload setting.**

To adjust correctly connect a 0-50V voltmeter across the field positive and negative.

Run the plant at the correct speed and apply full load, slowly turn the overload potentiometer counter-clockwise until the LED just lights then turn 30 degrees clockwise until LED off.

Apply overload, LED should illuminate for 15-20 seconds before output falls to approximately 50-80 volts AC.

Stopping the plant will automatically reset this function.

If load is not available an alternative test is to connect a 50 ohm rheostat in the field circuit (series) and by increasing the resistance this will cause the field voltage to increase until the desired maximum level is reached. (In the absence of any manufacturers detail a maximum field voltage of 46 - 48V can be used.)

#### 6. CONNECTIONS

##### a. STANDARD 3 PHASE 4 WIRE

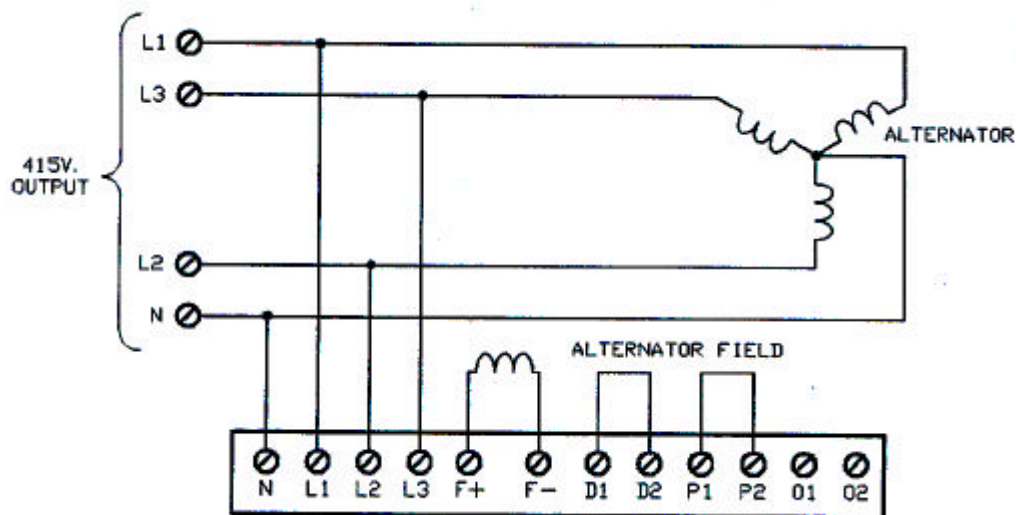

Figure 1

#### TRANSFORMER TAP SELECTIONS

(a) 415/240V - 415 tap

(b) 208/120V - 208 tap

## Power Drive Systems

### AVR 380 AUTOMATIC VOLTAGE REGULATOR

#### b. STANDARD 1 PHASE 2 WIRE

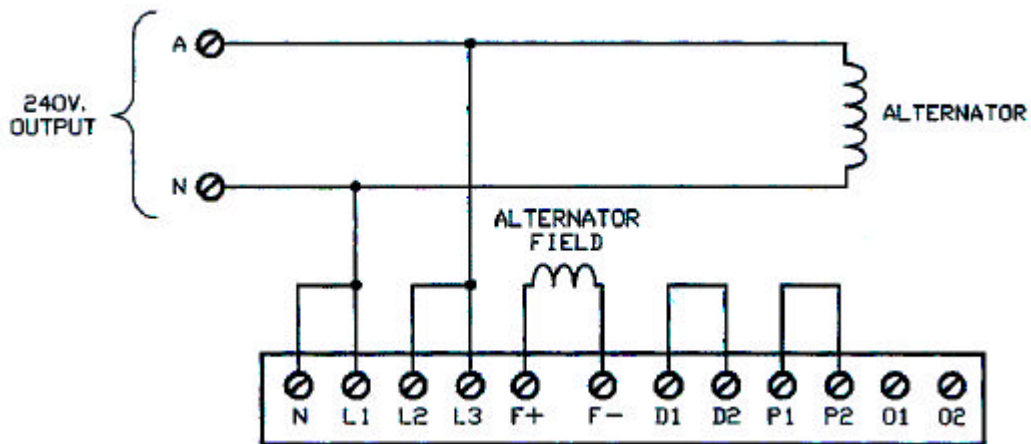

Figure 2

#### TRANSFORMER TAP SELECTIONS

(a) 240V - 240V tap

#### c. NON STANDARD 3 PHASE 3 WIRE

To be used in the event of a machine with field resistance higher than 50 ohms to ensure sufficient field excitation supply voltage is available.

#### Notes:

For non standard connection with L1-N and L3 on 415 Volt remove large green 10K Resistor, located next to transformer. It may become too hot and damage the PCB R14.

F- = XX & F+ = X on some machines.

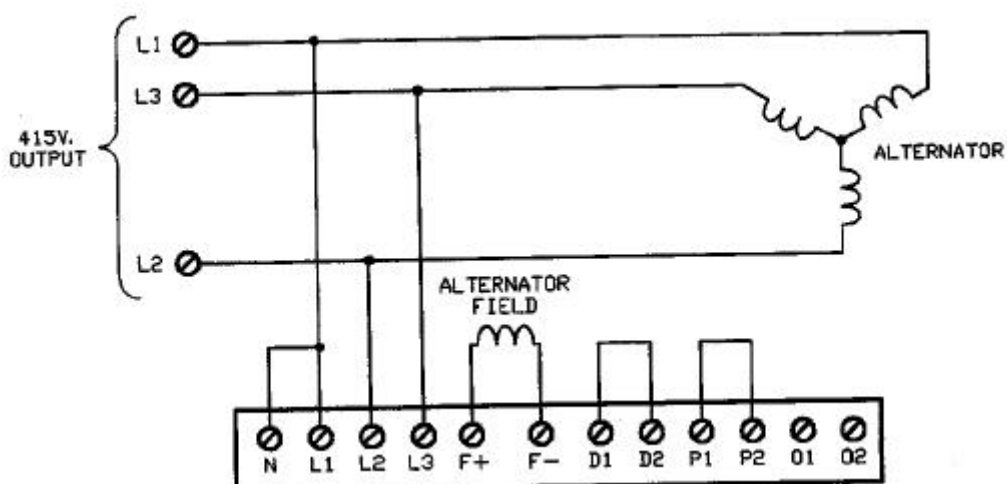

Figure 3

#### TRANSFORMER TAP SELECTIONS

(a) 415/240V - 415V tap

(b) 440v - 440tap

**Power Drive Systems**  
**AVR 380 AUTOMATIC VOLTAGE REGULATOR**

d. 415 Volt Alternator with 3ø 3 wire centre tap (208V) sensing & supply– similar to Cat Alternators.

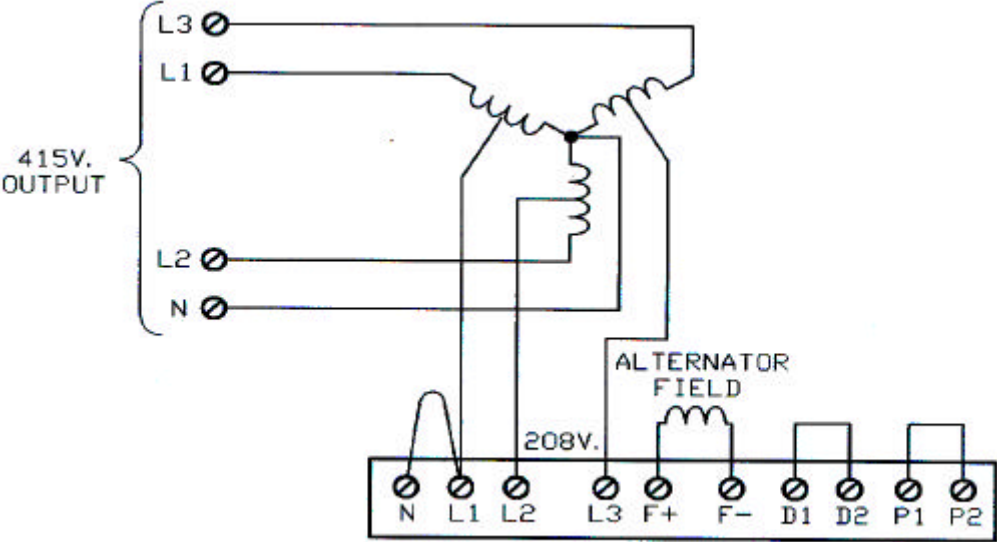

**Figure 4**

Transformer Tap Selections

208 Volts

e. 415 Volt Alternator with 2 phase sense 415 Volt & separate field supply winding 120 Volt, similar to Mecc Alte Alternators or the supply from a (PMG) Permanent Magnet Generator, Stamford Series 3. With this Connection, the power for the field is independent of the main output winding & as the result short circuit field forcing current is generated for 10 seconds.

Field Supply Winding or PMG exciter power

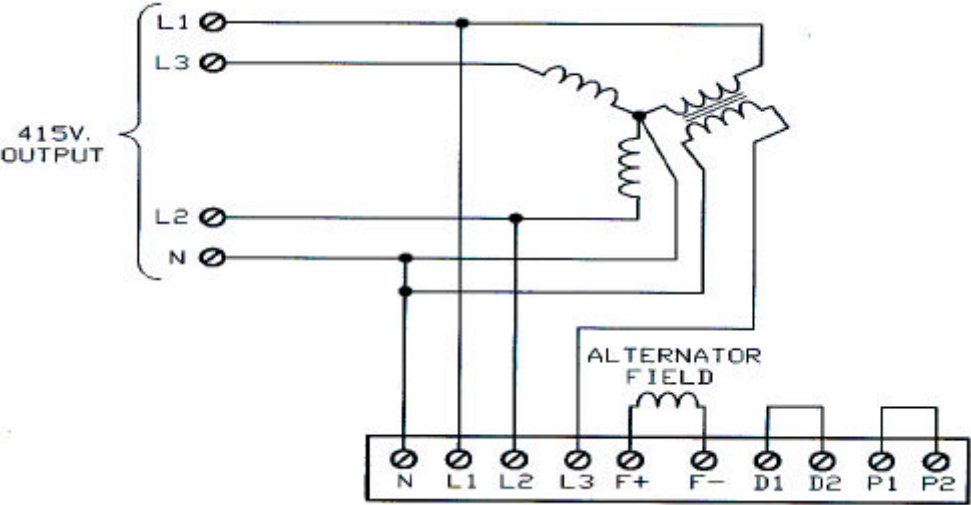

**Figure 5**

Transformer Tap Selection

415 Volts

## Power Drive Systems

### AVR 380 AUTOMATIC VOLTAGE REGULATOR

#### 7. RADIO INTERFERENCE

Additional RFI suppression can be achieved by connecting a 0.47MFD capacitor, rated at 250V AC between terminals N & L3.

#### 8. DROOP FACILITY

The AVR has quadrature droop facilities for parallel operations.

Quadrature droop allows load sharing of reactive load (KVAR) only since KW load is a function of the prime mover.

A current transformer with 5 amp output at 10VA secondary rating and ratio of twice the alternator output is required.

When this is used the loop between D1 and D2 must be removed.

The current transformer must be connected in the blue phase or L3. It is to be noted that the AVR senses Red L1 and Yellow L2 phase voltage and to achieve quadrature droop, current must be sensed in the blue or L3 phase.

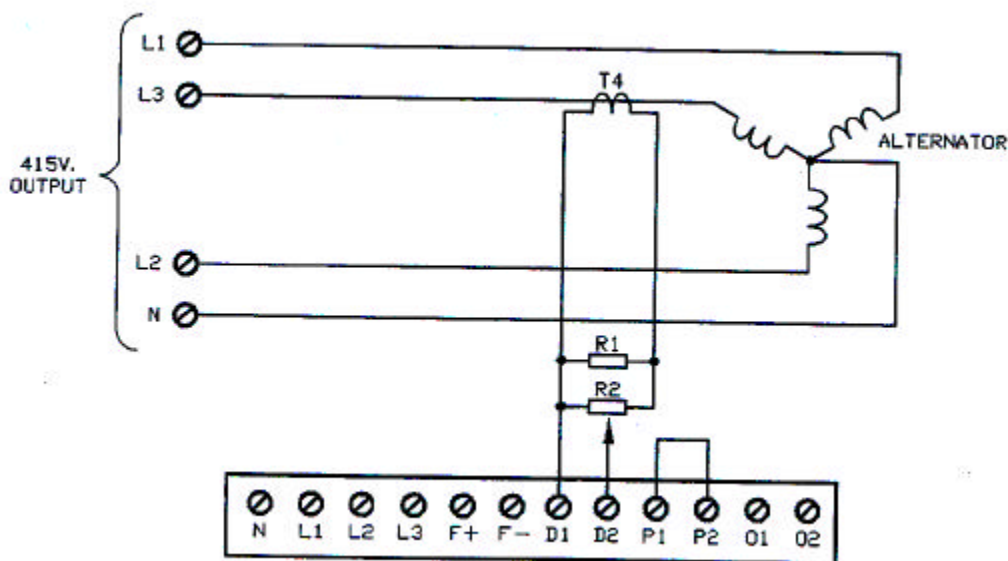

Figure 6

R1 1 ohm 25W

R2 adjustable 30 ohm 2W



## Power Drive Systems

### AVR 380 AUTOMATIC VOLTAGE REGULATOR

#### Notes:

R2 must be adjusted on both plants to give same voltage drop (approximately 5V/100%) for equal % of load for correct KVAR load sharing.

If rising voltage with load is detected the current transformer primary current flow direction must be reversed by reversing the transformer body. ie remove the primary turns and rotate transformer 180 deg and reconnect secondary, or swap position of secondary wires.

#### 9. SPECIFICATIONS

Voltage range 120, 208, 240 and 415Volts  
Selectable taps  $\pm 10\%$  adjustment on each range  
Maximum field current 10 amps  
SCR rated at 50 amps 1600 volts  
Suitable for single and three phase alternators 50 & 60 HZ  
Regulation  $\pm 1.5\%$  (1% can be attained on some machines)  
Temperature -10 deg to 60 deg  
Underspeed adjustment 10Hz-55Hz  
Time delay 15-20 seconds approximately fixed  
Residual voltage required for reliable excitation 3-5 volts  
Minimum field resistance 3-5 ohms  
Field voltage 50% of input sensing voltage

#### 10. REMOTE VOLTAGE CONTROL

The AVR has remote voltage facilities where the voltage range can be varied up to 10%.

Remove bridge from P.P. and fit external 5K linear 2W potentiometer. Turn the pot on the AVR fully clockwise so as to have maximum voltage range.

It is necessary to use screened cable for remote control, connect as Figure 5.

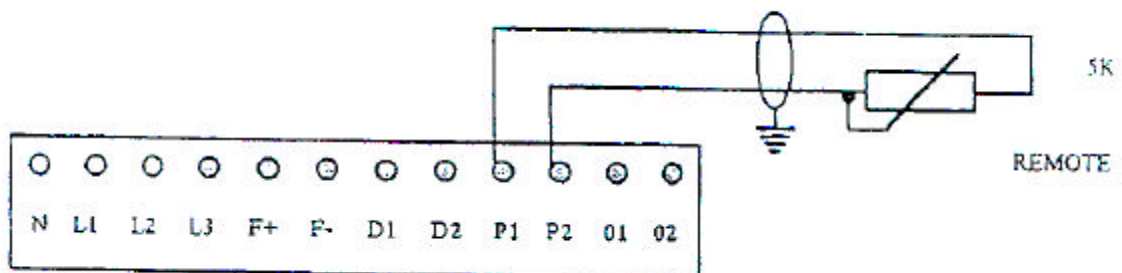

Figure 7

## Power Drive Systems

### AVR 380 AUTOMATIC VOLTAGE REGULATOR

#### 11. REMOTE OVERLOAD INDICATION

O1 and O2 terminals are used for remote indication of overload operation.

The output is an optical coupled NPN transistor, maximum output is 50ma suitable for LED driver, shut down signal or relay.

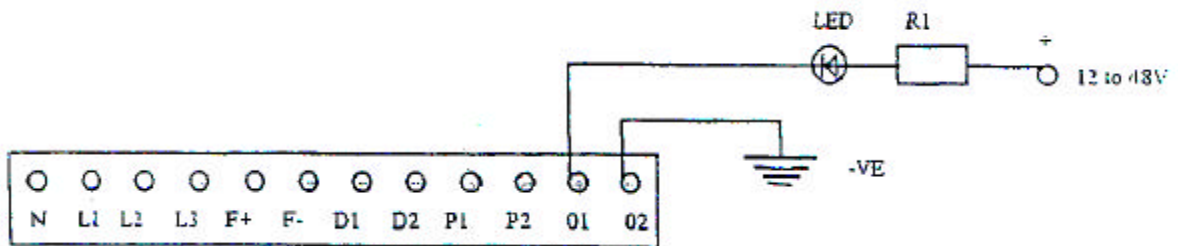

#### 12. VOLTAGE TRIM

The AVR 380 fitted with the optional voltage trim allow the output voltage of the generator to be adjusted by approx 10% from the auxillary supply of +/- 5 volt DC.

The input terminals are A1 and A2.

- A positive potential on A1 lowers output volts, maximum 5 volts adjust the voltage -10%.
- A negative potential on A1 raises output volts, maximum 5 volts adjust the voltage +10%.

The level of output voltage can be finely adjusted by the potentiometer under the terminals A1 and A2. Fully anti-clockwise no voltage trim and fully clockwise maximum trim.

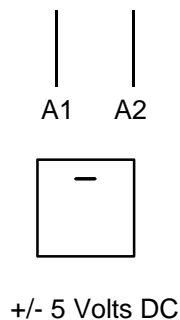

+/- 5 Volts DC

## Power Drive Systems

### AVR 380 AUTOMATIC VOLTAGE REGULATOR

#### 13. BENCH TEST

The AVR can be bench tested as follows

##### a. TEST CIRCUIT

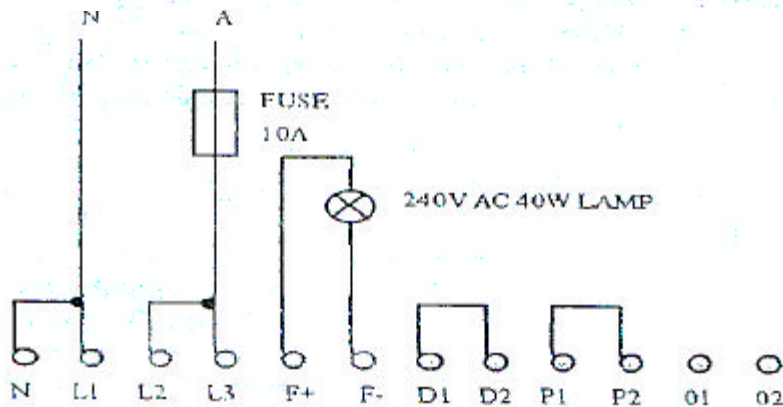

240C AC 50Hz

##### b. AVR TEST SETUP

###### TRANSFORMER TAP SELECTIONS

(a) 240V - 240V tap

##### c. TEST EQUIPMENT REQUIRED

A 240V 40 watt globe, complete with holder and wire

3 pin 240V mains plug and lead

Mains supply

##### d. PROCEDURE

1. Remove AVR from generator
2. Connect as above and select transformer tap to 240V position (note the original sensing voltage tap position)
3. Mark position of voltage adjusting potentiometer with biro or pencil (this enables the potentiometer to be returned to its original position)
4. Turn voltage adjusting potentiometer fully clockwise
5. Turn on the 240V supply
6. Volt globe should be illuminated and the overload LED should be on for 15-20 seconds, then go off
7. Turn 240V supply off (resets the overload)
8. Turn the voltage potentiometer fully anti-clockwise
9. Turn 240V supply on

## ***Power Drive Systems***

### AVR 380 AUTOMATIC VOLTAGE REGULATOR

10. 240V globe should just flash and then remain off
11. Turn the voltage adjusting potentiometer back to the original position or just passed. If the AVR was set to 240V as the mains then the light should again come on for 15-20 seconds and go off
12. If the AVR operates as the test procedure then the fault may be in the alternator
13. Reconnect to alternator making sure the **T/F sensing tap is returned** to its correct position and try again

# Power Drive Systems

## AVR 380 AUTOMATIC VOLTAGE REGULATOR

### 14. COMPONENT LAYOUT

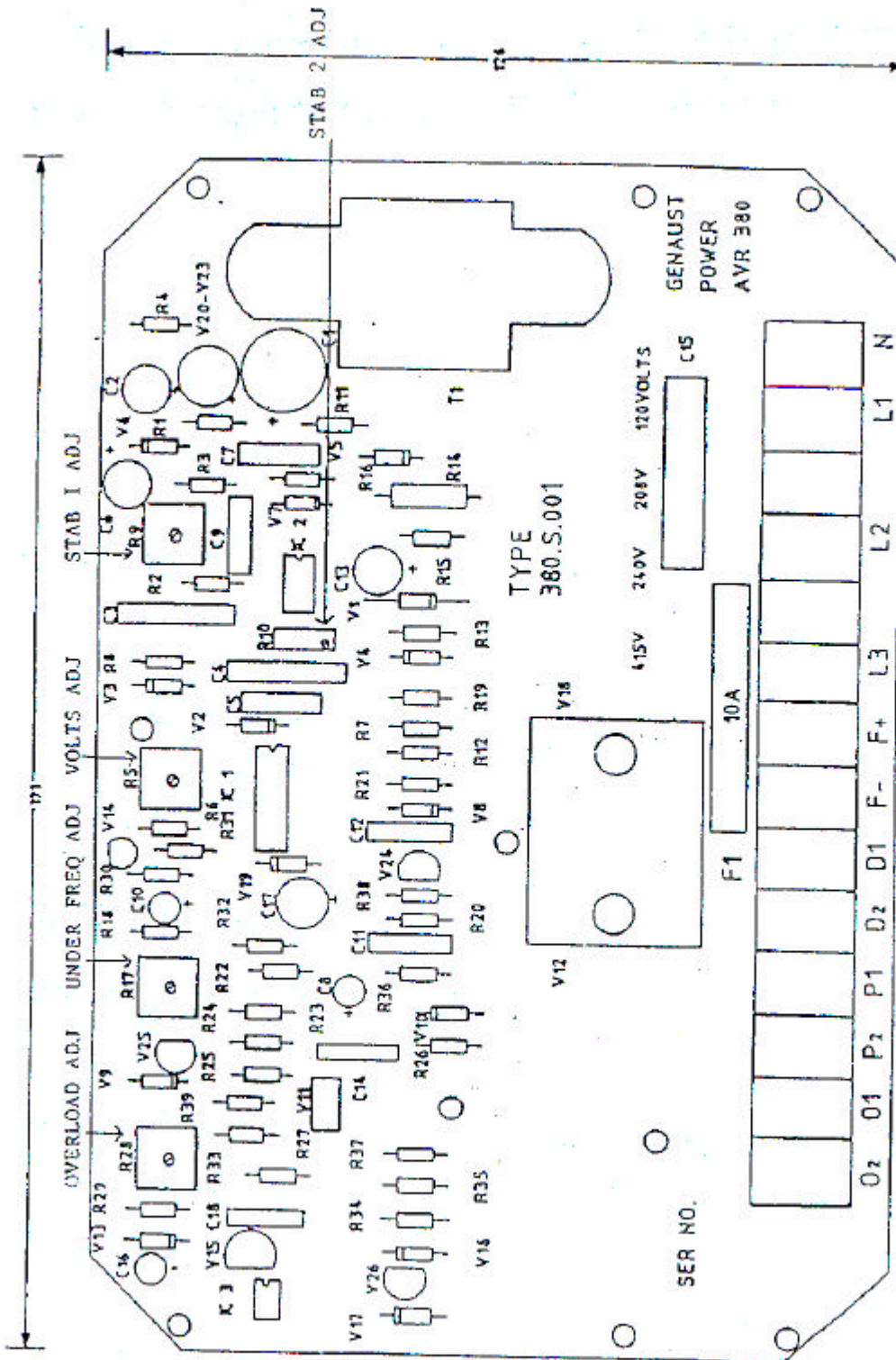

**Power Drive Systems**

**AVR 380 AUTOMATIC VOLTAGE REGULATOR**

**WARRANTY CLAIM PROCEDURE**

- (a) On identifying a possible component fault advise the company in writing the model and serial number of the component and major assembly it is part of as well as fault details
- (b) Remove and return the faulty component to the company following any tests or checks requested by the company

**BASIC WARRANTY CONDITIONS**

- (a) The warranty is a 12 month back to base warranty where the customer is liable for the re delivery costs
- (b) Items modified without the companies knowledge or approval may not be warrantable
- (c) If the company is required to inspect / remove or reinstall any part of the goods, the customer will be liable for any out of pocket expenses
- (d) Major third party items such as engines and alternators are subject to the original manufacturers warranty only
- (e) The warranty does not cover inter alias, loss of damage due to accident misuse or fair wear and tear

---

**WARRANTY REGISTRATION**

**CUSTOMER NAME:** \_\_\_\_\_

**ADDRESS:** \_\_\_\_\_

---

**TELEPHONE No:** \_\_\_\_\_ **FAX No:** \_\_\_\_\_

**ITEM MODEL No:** \_\_\_\_\_ **SERIAL No:** \_\_\_\_\_

**SUPPLIER NAME:** \_\_\_\_\_

**DATE PURCHASED:** \_\_\_\_\_